

**Unpack and Install System**

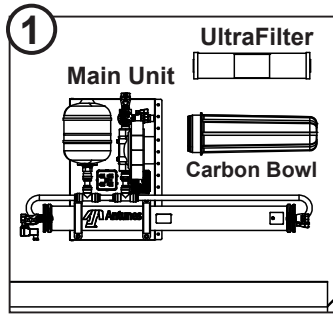

Unpack carton and identify parts.



Identify location to install the system.

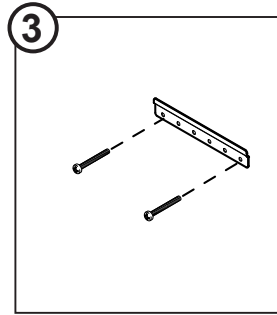

Mount the wall bracket.

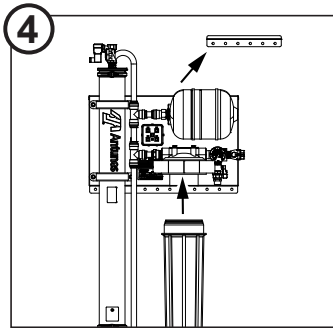

Hang system and install empty carbon bowl.

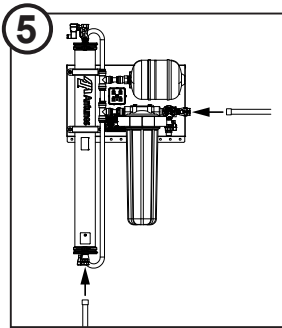

Connect inlet and outlet plumbing.

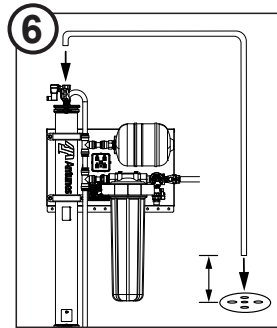

Install drain line to drain.

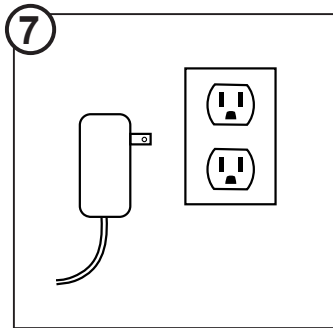

Plug power supply into outlet.

**Rinse Ultrafilter**

**NOTE:** Ultrafilter must be rinsed before use.

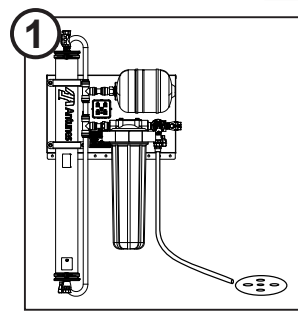

Connect RINSE hose.

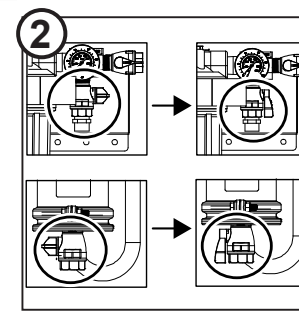

Open RINSE valve and INLET valve.

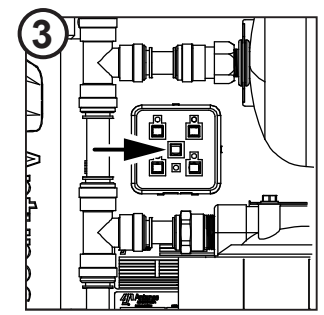

Push FLUSH button 6 times.

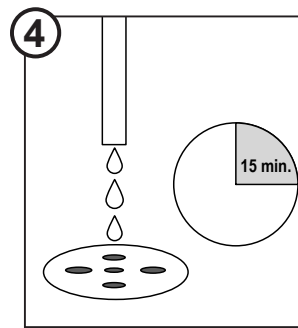

Rinse for 15 minutes.

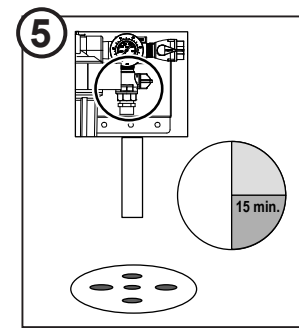

Close RINSE valve and wait 15 more minutes.

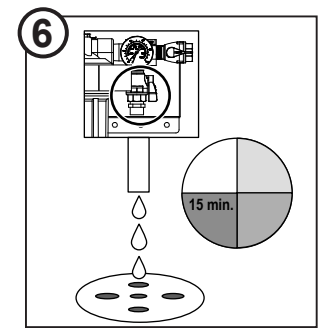

Open RINSE valve and rinse for 15 minutes.

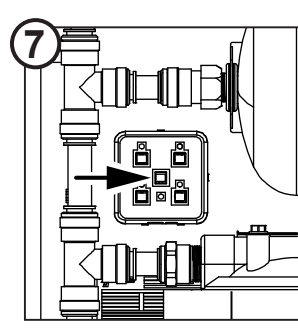

Push FLUSH button 6 times.

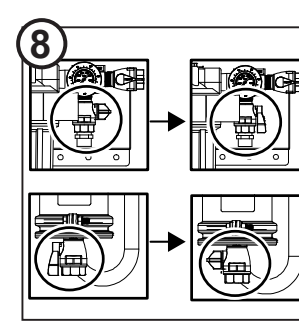

Close INLET valve and RINSE valve.

## Rinse Carbon

**NOTE:** Carbon must be rinsed before use.

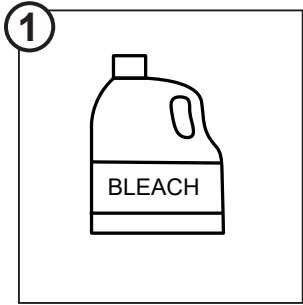

Sanitize system.

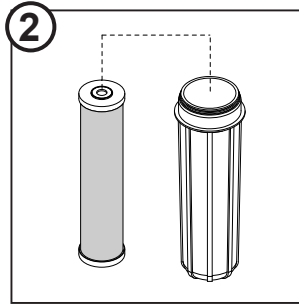

Install Carbon Element in Bowl.

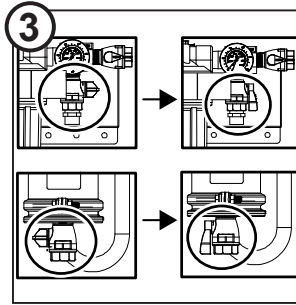

Open RINSE valve and open INLET valve

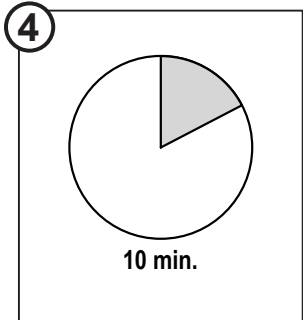

Rinse for 10 minutes.

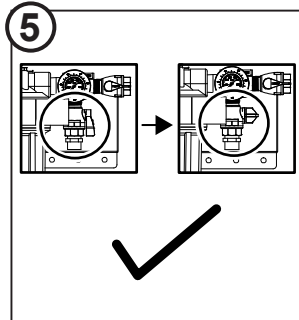

Close RINSE valve.  
System is ready for use.

## Maintenance

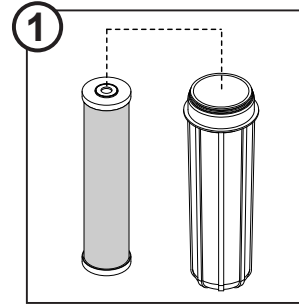

Change Carbon Element every 12 months.

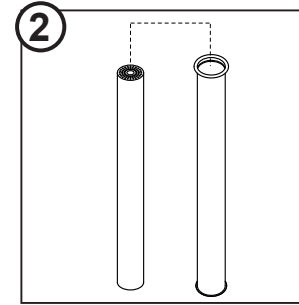

Change Ultrafilter cartridge every 3 years.